

Article number: 2310431059

Description: E+G Levelling elements
LX.30-SW17-M8X21

Measures

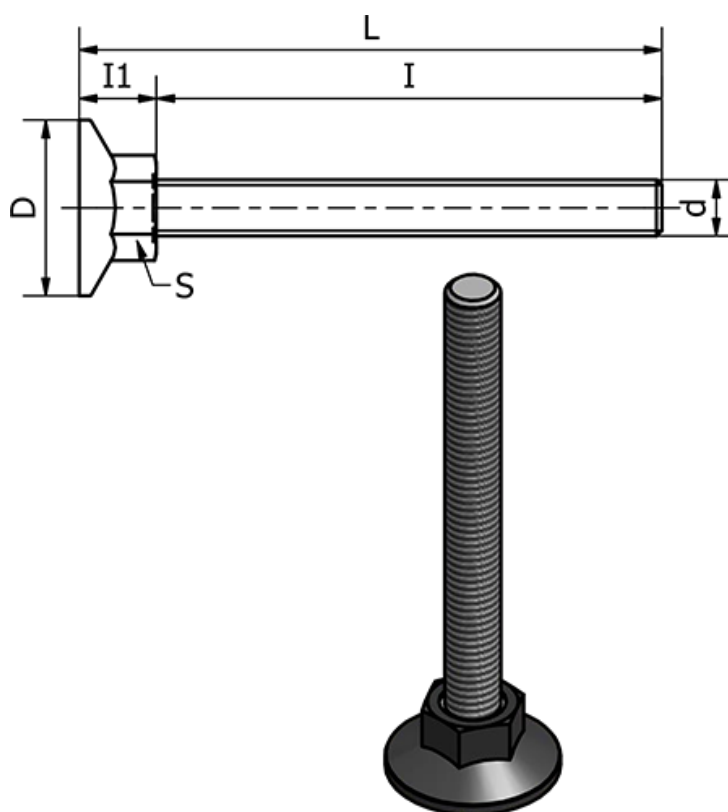

d = M8

D = 30

I = 21

I1 = 12

L = 33

S = 17

Static load in (N) = 2500

Type = Forzinket

Weight (g) = -